

Instruction manual

Wireless 2D barcode scanner with screen

V1.2

Dear users, thank you for choosing our products. We will serve you with high-quality products, in order to ensure that you use this product better, please read this manual carefully before use!

Product features

1. Using CMOS camera module, can identify one, two-dimensional code and screen code.
2. Equipped with OLED display, real-time display of power connection status and other information
3. Equipped with inventory function, you can directly carry out some daily simple inventory work. All parameter settings of this product can be completed by scanning the setting code, and saved in the memory of the barcode scanner, and the inventory content and parameter settings can still be retained after the power is turned off.
4. With the function of scanning code pairing, simple and fast completion of transmit/receive pairing work (this product has been paired at the factory).
5. The transmission distance is long, about 80 meters in the open space (indoor transmission distance is generally 20-30 meters according to different structures and environments).

Interface description

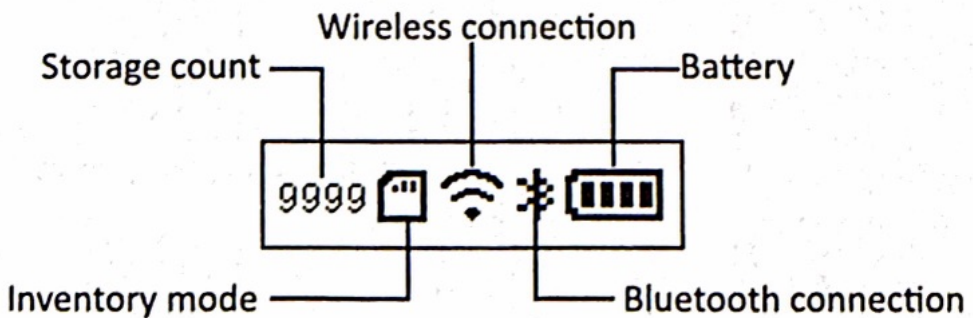

Bluetooth connection

after the code scanner is powered on, open the bluetooth search at the receiving end, find the bluetooth device named "barcode scanner", click to connect, and display the icon  on the display after success. (available for bluetooth version)

Bluetooth settings



Bluetooth HID



Bluetooth SPP



Bluetooth BLE



Clear the pairing information

General settings



Factory reset



Software version number



Allows all barcodes to be read

Communication mode settings



**USB HID mode



Virtual serial port mode

Common terminator settings



**CR



CR+LF



Tab



No terminator

Reading mode settings



**Manual mode



Induction mode



Continuous mode

Sounds settings



**Turn on buzzer



Turn off buzzer



**Turn on Voice



Turn off Voice



**Turn on vibration



Turn off vibration

Wireless function settings



**Normal mode



Inventory mode



Data does not lose mode
(Instant upload + storage mode)



Data upload



Clear data

Illustrate:

1. Normal mode: Scan the barcode to enter normal mode, in this mode will upload the scan results to the computer in time (this mode is the default mode).
2. Inventory mode: scan the barcode to enter the inventory mode, in this mode will store the scan results in the internal memory, the screen will display the inventory mode icon  (when the internal memory is occupied, the buzzer will "long beep" to prompt).
3. Data no loss mode: scan the barcode to enter the data no loss mode, in this mode, when there is a signal, the scan result will be uploaded to the computer in time; When the signal is weak or there is no signal, the scanning results will be stored in the internal memory, and the stored data will be automatically uploaded to the computer when waiting for a signal.
4. Data upload: Scan the barcode to upload the data stored in the internal memory to the computer in turn (applicable in inventory mode and data no loss mode, please ensure that the wireless signal is normal when uploading data, the data upload successful buzzer will "beep" 2 times, data upload failure buzzer will "beep" 3 times).
5. Stored count: The screen of the barcode scanner will display the total number of stored data.
6. Clear data: Scanning the barcode will clear all the data in the internal memory.

One-click pairing function



pairing

Scan the above pairing code, the scanner will continuously send out the pairing voice prompt, plug the receiver into the USB port of the computer, the voice prompt pairing is successful, and the screen displays the icon  when the connection is successful

Sleep time settings

Note: Scan the sleep time SET first, and then scan the time you want to set



Sleep time SET



30s



**60s



2 min



5 min



No hibernation

Language settings



**United States



Belgium



Brazil



Canada



Croatia



Czech



Slovakia



Denmark



Finland



France



Germany



Hungary



Italy



Latin America



Netherlands



Norway



Poland



Portugal



Serbia



Slovenia



Spain



Sweden



Swiss - French



Swiss - German



United Kingdom



Turkey-F



Turkey-Q



Japanese



Romanian



Greece



Hebrew



Russia



Universal keyboard

Reverse reading settings



** turn off



turn on

Easy maintenance method

1. Stains and dust on the scanning window sometimes affect the work of the scanner. When cleaning, use a good quality facial tissue and wipe gently. Then blow clean with a blowing balloon. If you use paper with poor paper for a long time, it will damage the surface finish of the scanning window and affect the reading effect of the scanner.
2. The shell of the scanner can be wiped with a soft cleaning cloth. If necessary, add a small amount of dish soap to water, dip it in a soft cloth and wipe it